

SPECIFICATIONS

(RoHS Compliant)



Model Number: PQD12B3-E3

Version:00

Part Number: 17001204A

Jun 13, 2018

Mechanical Drawing:

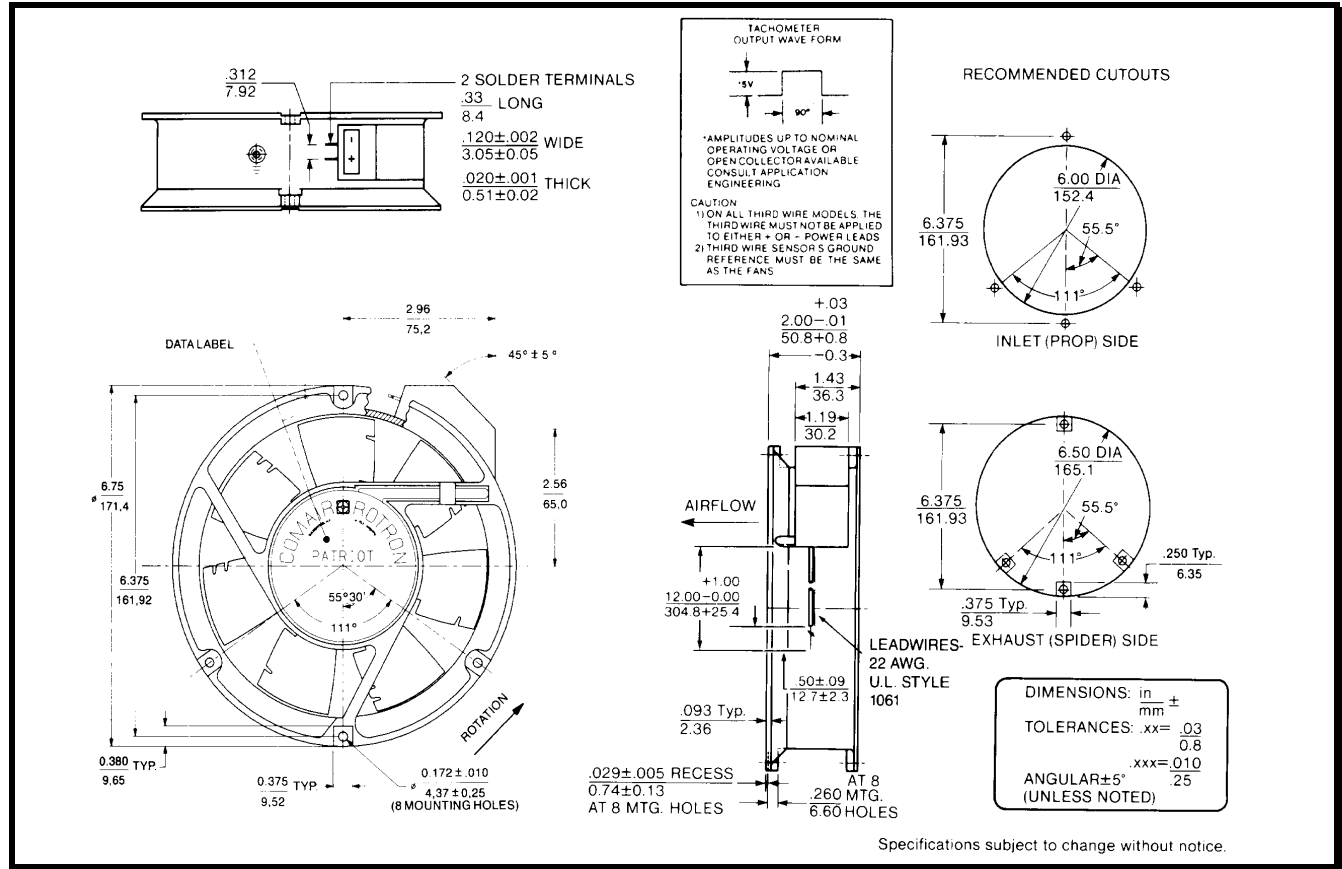

Motor:

Nominal Voltage	= 12 vdc
Operating Voltage Range	= 8 – 16 vdc
Nominal Running Current	= 2.260amps
Locked Rotor Current	= 4.00 amps
Running Power	= 27.1 watts
Average Speed	= 3400 RPM
Bearings	= Ball
Air Flow	= 235 CFM
Acoustic	= 54.3 dBA

Construction:

Venturi: Single piece, die-cast aluminum, Black
 Propeller: Plastic, Black, UL 94V-0

Life Expectancy:

This fan is designed for continuous duty life of 58,000 hours at 70°C.

Additional Features:

Brushless DC Motor
 Polarity Protected
 Locked Rotor Protection
 Automatic Restart Capability
 Operating Temperature: -10°C to 70°C
 Storage Temperature: -40°C to 85°C
 Environmental Protection: Type 3(IP68)

Termination:

12" Lead wires, AWG 22, UL 1061
 Red = Power (+)
 Black = Return (-)

Agency Approvals:

UL, CUL, CE

PQ Curve:

