

Sales Outline Drawing

Revision **A**

Specifications:

Impedance (Ω)	$8 \pm 15\%$ at 2000 Hz at 1.0 V
Rated Power (W)	0.7
Max Power (W)	1.0
Resonance Freq Fo (Hz)	$550 \pm 20\%$ at 1.0V $860 \pm 15\%$ at 1.0V in 1cc closed box
Frequency Range (Hz)	Fo ~ 7000
Output S.P.L. (dB)	88 ± 3 at 0.7w/0.1m 3.0kHz in 1cc closed box 70 ± 3 at 1w/1m 3.0kHz in 1cc closed box
Magnet	Nd-Fe-B
Frame Material	PPA
Operating / Storage Temp	-40 to 60°C/ -40 to 85°C
Weight (g)	1.2
Options	For other options contact factory

Dimensions: ± 0.2 (units: mm)

ROHS Compliant

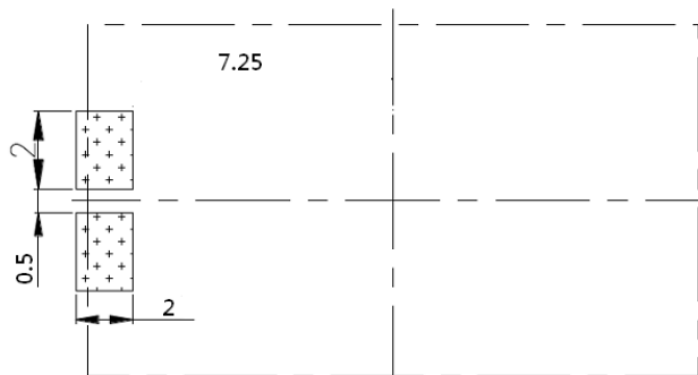
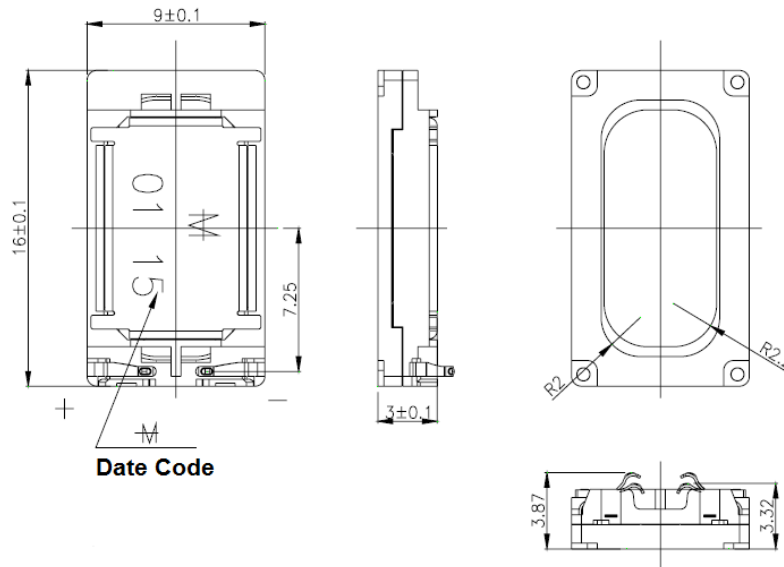

Recommended PCB Layout