

TOP VIEW
TOP OPENING

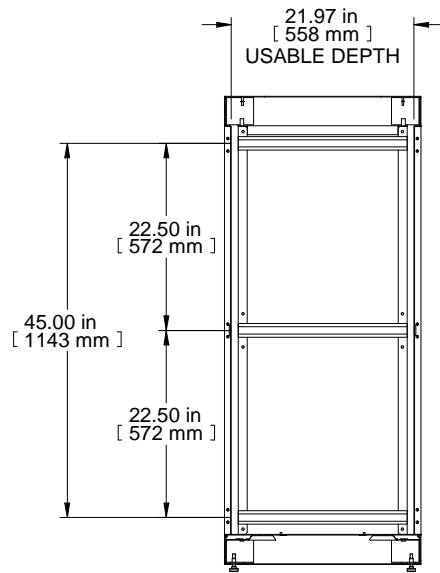

SECTION B-B

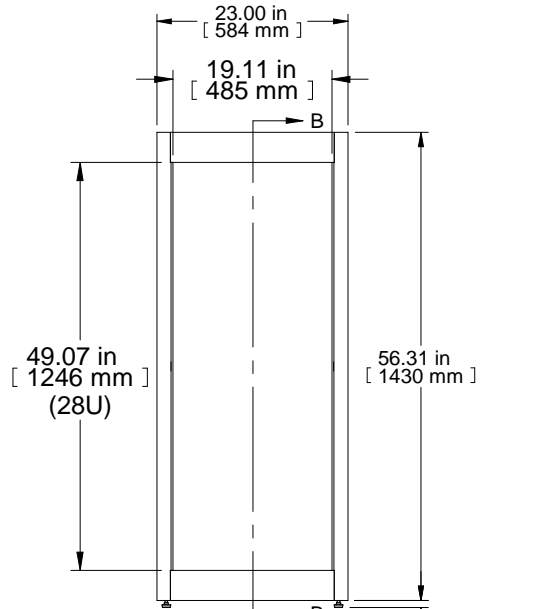

FRONT VIEW

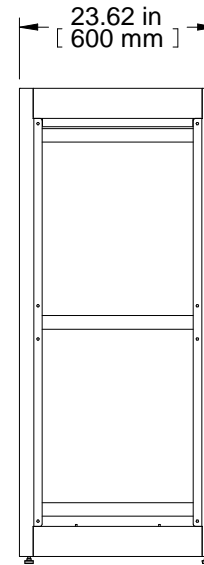

R.S. VIEW

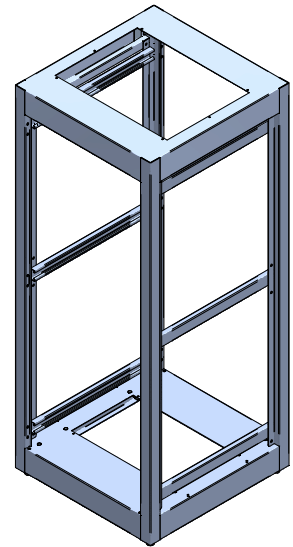

ISOMETRIC

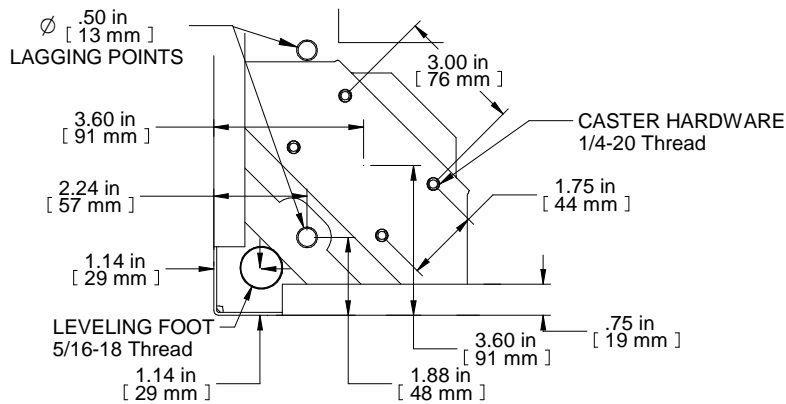

DETAIL A 4X
SCALE 5:1

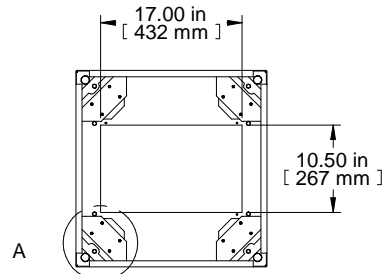

BOTTOM VIEW
BOTTOM OPENING

PART NUMBER.	
C2F194923 BK1	PAINTED BLACK TEXTURE
C2F194923 LG1	PAINTED LIGHT GRAY TEXTURE
NOTES	
- Material 14 GA. Steel Welded Assembly	
- See Hammond Website for Frame Accessories.	
Français	
Pour tous les détails sur nos produits, svp veuillez consulter notre site www.hammondmfg.com	
Data subject to change without notice. Isometric drawing not to scale. Les données sont sujettes à changement sans préavis.	
	HAMMOND MANUFACTURING. www.hammondmfg.com
PART NO. C2F194923	